



# **OPERATING INSTRUCTIONS**

## **GÄVLE ENERGY PORT**

### **SHIP - SHORE**



# Contents

1	General .....	5
1.1	General rules .....	5
1.2	Restricted areas.....	5
1.3	Knowledge of the regulations.....	5
1.4	Risk management.....	5
1.5	Time Slot Gävle – Queueing system .....	5
2	Ship/shore.....	7
2.1	Ship/Shore Safety Check-List .....	7
3	Technical description of the jettys .....	7
3.1	Jetty 27 .....	7
3.2	Jetty 1 .....	7
4	Jettying.....	7
4.1	Approaching jetty .....	7
4.2	Remaining at jetty .....	7
4.3	Mooring line materials.....	7
4.4	Alongside jettying.....	7
4.5	Jettying routines.....	8
4.6	Authorized traffic.....	8
4.7	Weather restrictions .....	8
4.8	Electric storms .....	8
4.9	Onshore power for tankers .....	8
4.10	Technical requirements for tanker connecting to onshore power at jetty 27 .....	9
5	Technical description of the pipelines .....	10
5.1	From jetty 27.....	10
5.2	From jetty 1.....	10
6	Emergency procedures .....	10
6.1	Responsibility.....	10
6.2	Alarm facilities.....	10
7	General rules for tanker vessels at jetty .....	10
7.1	Warning signals .....	10
7.2	Spark extinguishers .....	11
7.3	Fire safety .....	11
7.4	Watchmen on deck.....	11
7.5	Smoking.....	11
7.6	Open fire – hot work on-board .....	11
7.7	Repair work.....	11
7.8	Application .....	11
7.9	Sparks .....	11
7.10	Tank hatches and sounding hatches .....	11
7.11	Inert gas facility.....	11



7.12	Loading, discharging, bunkering and de-ballasting.....	12
7.13	Measures to prevent pollution of land and water areas .....	12
7.14	Safety facilities on land.....	12
7.15	Photography and filming.....	12
7.16	Inspection .....	12
8	General rules in the Energy port .....	12
8.1	Smoking and open fires.....	12
8.2	Hot work, safety distance.....	12
8.3	Vehicular traffic.....	12
8.4	Electric equipment .....	13
8.5	Repair work, safety distance.....	13
8.6	Fire safety.....	13
8.7	Spillage and leakage .....	13
8.8	Entry to the Energy Port.....	13
8.9	Life jacket .....	13
9	Loading/discharging of petroleum products and liquid chemicals.....	13
9.1	Cargo handling .....	13
9.2	Loading hoses .....	13
9.3	Heavy fuel oil pipeline, jetty 1 .....	13
9.4	Jetty personnel .....	13
9.5	Emergency measures in case of fire, oil spillage or accident.....	14
9.6	Transfer pumping between depots .....	14
10	Bunkering.....	14
10.1	Regulations.....	14
10.2	Bunkering manager .....	14
10.3	Method of delivery .....	14
10.4	Pre-notification, restrictions .....	14
11	Tanker cleaning .....	14
11.1	General.....	14
12	Summary.....	14
12.1	Class 1 products (Petrol) .....	14
12.2	Class 2 products (Jet A1, Kerosene).....	14
12.3	Class 3 and Other products (EO 1-5, Diesel, Biofuels).....	15



Appendixes:

Appendix 1	Map of the Energy port
Appendix 2	List of emergency contacts
Appendix 3	Instructions in case of fire
Appendix 4	Bollards Jetty 1
Appendix 5.1	Jettying procedures, vessels of less than 130 metres LOA
Appendix 5.2	Jettying procedures, vessels of between 130 and 180 metres LOA
Appendix 5.3	Jettying procedures, vessels of above 180 metres LOA
Appendix 6	Jetty Questionnaire Port of Gävle 20190425
Appendix 7	Flowchart jetty 1 and 27
Appendix 8.1	Checks pre-arrival Ship/Shore Safety Check-List
Appendix 8.2	Checks after mooring Ship/Shore Safety Check-List



# 1 General

## 1.1 General rules

These operating instructions have been approved by the Board of Port of Gävle AB and are applicable in conjunction with the provisions of the current Port Regulations and Port Rules. The above documents can be downloaded from Port of Gävle AB's website <https://gavlehamn.se/en/service-and-terminals/>. Additionally, the port operations are regulated by the directions and recommendations issued by Drivkraft Sweden, the Swedish Energy Ports Forum (SEHF) and the latest edition of the "International Safety Guide for Oil Tankers and Terminals (ISGOTT)". Maritime security is regulated by the ISPS code.

## 1.2 Restricted areas

These regulations cover all operations within Gävle Energy Ports including Fredriksskans Jetty 1 and Jetty 27, as well as the pipeline system to the various Terminals, see Appendix 1.

## 1.3 Knowledge of the regulations

All those working in the restricted area are obliged to adhere to these regulations.

## 1.4 Risk management

Petroleum products and chemicals can produce gases that are hazardous from a fire and health perspective. Particular attention should therefore be paid to preventing damage to people, property and the environment.

Open fires and smoking are forbidden within the applicable area.

The carrying out of all hot work is strictly forbidden within the restricted area. Temporary exceptions to this prohibition can be granted to operators that have consulted with Gästrike Fire department or operators that have routines and procedures for granting of the exception approved by the Gästrike Fire department.

Within the EX-area, mobile phones, communications equipment, torches (flashlights) and other electric/electronic equipment must be EX-classified, otherwise all such equipment must be left outside the EX-classified area.

All those visiting the area must wear safety helmets, safety shoes and visibility clothes and other designated protective clothing. Eye protection and/or safety masks must be worn when so instructed by work managers. Life jackets are compulsory on the jettys.

Vehicle traffic is regulated by general traffic rules, and there is a general speed limit of 30 km per hour within the port area. Flashing/rotating warning beacons must be used in working areas.

Use of drugs or alcohol will lead to immediate expulsion from the area, and a report will be filed with the appropriate authorities.

## 1.5 Time Slot Gävle – Queueing system

The Time Slot Gävle queueing system is mandatory for all vessels calling at jetty 1 and 27 in port of Gävle according to 19§ of the Port Rules.

The queueing system is digital where the vessel applies for a time slot by a web form no earlier than 72h for jetty 1 or 36 hours for jetty 27 before arrival in the outer port area. The application can be submitted earlier than 72h or 36 hours depending on jetty before arrival in the outer port area, but only becomes active 72h or 36 hours before arrival.

The vessel receives a suggested RTA (Recommended Time of Arrival) based on the vessel's stated



ETA to the outer harbor area and any queue to the current jetty.

The time slot is maintained for up to 3 hours of delay. The vessel must then remove the current time slot and apply again for a new time slot.

If there is a change in queue, vessels may receive a new RTA. This new RTA must always be confirmed by the vessel.

During the vessel's sea voyage, the jetty laytime specified in the application for a time slot must be immediately adjusted if it becomes known to the vessel that the estimated jetty laytime has changed.

If there is an abnormal event or major delay, the Port Traffic Office in Gävle harbor must always be notified immediately by phone, +46 26 17 88 66.

Port of Gävle, always has the right to change the current queuing order according to the Port Rules.

### OUTER PORT AREA

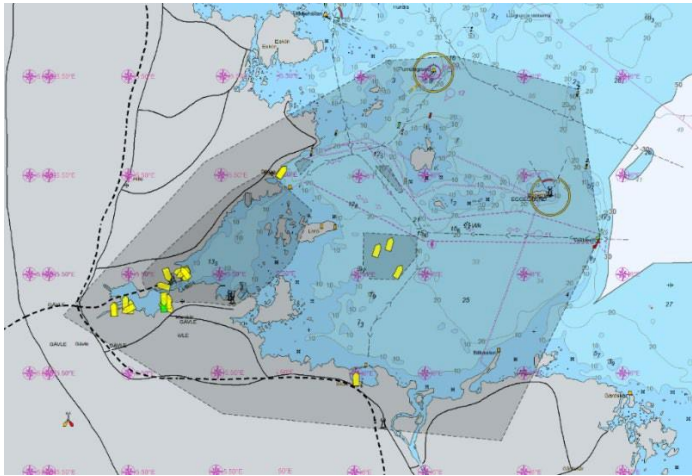

### ALONGSIDE THE JETTY

When the vessel is at the jetty, the jetty laytime by the link to the application for a time slot should not be updated.

When a vessel is at the jetty, the terminal's representative, i.e. Loading Master, in consultation with the vessel's Master continuously throughout the port call, should update the vessel's ETD in the Port Activity App.

Minor time deviations during an update of the ETD do not have an immediate impact on vessels in the queue for jetty 1 and jetty 27, but give all port actors and arriving vessels clear information about when the current vessel at the jetty plans to depart.

Current queue is available in the app Port Activity App™ under the tab "Queue" and on the website [www.portactivity.se](http://www.portactivity.se)

More information on how to apply for a time slot is available at [www.gavlehamn.se/en/traffic-information/](http://www.gavlehamn.se/en/traffic-information/)



## 2 Ship/shore

### Ship/Shore Safety Check-List

2.1 Port of Gävle AB's Ship/Shore Safety Check-list is available as Appendix 8.

Also follow link for editable PDF part 1-2: <https://gavlehamn.se/en/service-and-terminals/>

Also follow link for editable PDF part 3-9: <https://gavlehamn.se/en/service-and-terminals/>

## 3 Technical description of the jettys

### 3.1 Jetty 27

- Designated for offloading and loading of petrol, diesel, kerosene, Jet A1 and similar products.
- A total of four hydraulic-operated marine loading arms, two of 10" and two of 12", working space is described in Appendix 6.
- The marine loading arms are equipped with insulating flanges.
- There is no gas recovery connected to the jetty.
- The jetty is 80m long and the jettying deck is 2.9m above the average water level.
- The jetty is equipped with four fenders.
- The bollards on the mainland are equipped with quick-release mechanisms.
- See Appendix 6 for further information.
- See Appendix 7 for information about products and manifolds at jetty.

### 3.2 Jetty 1

- Designated for offloading and loading of heavy oils, slurry, MTBE and liquid chemicals.
- The heavy fuel oil pipeline is served by a loading hose with an 8" coupling, 15 + 7m in length. The jetty manifold is equipped with insulating flanges.
- There is no gas recovery connected to the jetty.
- There is a small hydraulic crane on the jetty. Working space – SWL: 1.8m – 3.87t to 12.2m – 0.32t.
- The jetty is constructed from three monoliths connected by footbridges. Total length is 87m and 1.85m above the average water level.
- There are three fenders on the middle monolith and two fenders on each of the outer monoliths. The fenders are composed of 12 car tyres hanging horizontally on a steel beam and secured with a chain in the monoliths.
- See Appendix 6 for further information.
- See Appendix 7 for information about products and manifolds at jetty.

## 4 Jettying

### 4.1 Approaching jetty

Pilot/vessel shall establish contact with safety personnel on jetty, before jettying. Contact should be taken by VHF channel 8 in good time before jettying jetty 27.

### 4.2 Remaining at jetty

Vessels that are not loading or discharging are not permitted to remain at jetty in the Energy port's jettys without the permission of Port of Gävle.

### 4.3 Mooring line materials

Tank ships may only be moored using rope lines or wire with sabs.

### 4.4 Alongside jettying

Jettying of vessels and other floating craft alongside another ship may only take place with the permission of Port of Gävle.



#### 4.5 Jettying routines

Recommendations issued by "Oil Companies International Marine Forum (OCIMF)" published in "Mooring Equipment Guidelines" must be followed to the extent possible.

Jetty 1	Appendix 4
Jetty 27 LOA 80-130m	Appendix 5:1
Jetty 27 LOA 130-180m	Appendix 5:2
Jetty 27 LOA 180<	Appendix 5:3

#### 4.6 Authorized traffic

Vessels and other floating craft are not permitted to access or jetty in the Energy port without the permission of Port of Gävle. Gates to each jetty 1 and jetty 27 must be kept closed to prevent unauthorized traffic from coming out on the jetty.

#### 4.7 Weather restrictions

Max. wind speed allowed for loading/discharging: 22m/s.

At wind speeds of 25 m/s the marine loading arm must be drained and disconnected.

The above should be considered a recommendation only, and does not diminish the responsibility of the Ship's master or Loading master. Port of Gävle may decide to make exceptions to these restrictions if such is deemed necessary based on the expected/prevailing weather conditions.

#### 4.8 Electric storms

During impending thunderstorms, all handling of Class 1 products or other operations that generate flammable gases must be stopped. All tank openings and valves on-board must be closed including by-pass valves in the ventilation system. All valves connected to the marine loading arm and the shore manifolds must be closed.

#### 4.9 Onshore power for oil tankers

Port of Gävle offers Onshore Power Supply (OPS) to tanker vessels according to the port rules 15§.

The vessel bears the full responsibility that it is fully compatible with the onshore power facility of Port of Gävle, technically as well as in terms for safety according to section the 4.10.

Notification to be able to use Onshore Power Supply shall be made according to section 15§ of the port rules. In addition, with each notification, the vessel shall also state the power in kVA that is desired the current vessel call.

Before the first connection to the OPS system, the vessel must obtain approval from Port of Gävle.

Jetty 27 is EX-classified according to Swedish regulations, which means that the ship must ensure that the ship's equipment and procedures are in line with current ATEX regulations and EN IEC standards, i.e. EN 60079-10-1 and IEC 60092-502.

With a ship intending to connect to the port's OPS, it is of the utmost importance that the ship follows the port's routines when connecting and operating.

The SSSCL (Ship Shore Safety Check List) from Port of Gävle contains a couple of specific items regarding OPS which the vessel shall fill in before connecting to the OPS system. In addition, continuous monitoring of the OPS cable shall be done according to SSSCL part 8 and 9.

Information on routines can be downloaded from the port's website [www.gavlehamn.se](http://www.gavlehamn.se)

Below is a schematic view of the OPS routine during connection and operation.



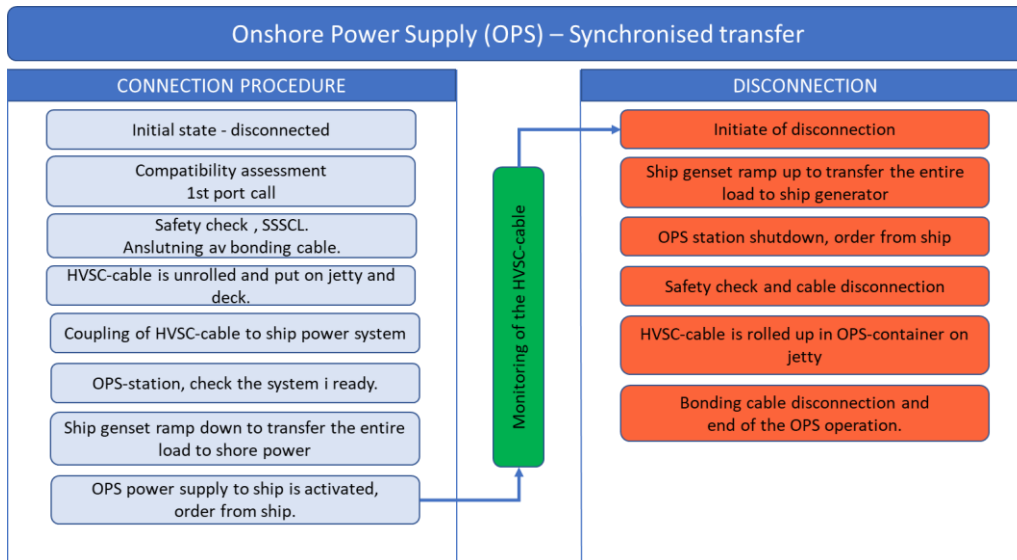

### 4.10 Technical requirements for tanker connecting to onshore power at jetty 27

To be filled in and sent to Port of Gävle prior the first connection to the OPS-system.

Vessel name:..... IMO No:.....

		STATUS	REMARKS
1.	The ship has a high voltage shore connection (HVSC) system according to the standard IEC/IEEE 80005-1 2019?		
2.	The ship can receive incoming voltage of 6 600 volt (6,6 kV) and with frequency of 50 Hz? Required kVA.....		
3.	The ships inlet contact for shore connection is of type Cavotecs PC6 with seven pilot contacts?		
4.	The ship has a connecting room that fulfil requirements for an explosive safe atmosphere where the power plug shall be connected? (IEC 60092-502)		
5.	The connecting room shall be equipped with safety circuit that are monitoring: <ul style="list-style-type: none"> <li>- a switch for closed door</li> <li>- detector for oxygen level, O<sub>2</sub> &lt; 5 %</li> <li>- gas detector for explosive gases</li> <li>- overpressure sensor</li> </ul>		
6.	A fixed point at mid-ship to connect a bonding cable from the terminal. A connector, ball bolt, according to standard SS-EN 61230 and picture blow. (Stud bolts (M12), washers, locking pins and stainless steel self-locking nuts.) Ball bolt with maximum 35 mm gap. Ball bolt diameter of 25 mm.		





7.	The ship shall have a mechanical cable clamp on the ships railing to hold the cable, diameter Ø 66-69 mm. It shall have the function that does not allow the cable bending more than a radius of 660 mm.		
8.	An instruction onboard for placing, fixing och connecting the connecting cable on the ship, from railing to the connecting room.		
9.	A person onboard that has the responsible for the 6,6 kV shore connection onboard, the person is <b>Person-In-Charge PIC</b> .		
10.	The ship shall have a crane onboard to lift and place the connecting cable from the terminal to the connecting room.		
11.	The terminal owns the connecting cable and the ship crew has the fully responsibility to handle it correct so no damages will occur.		

## 5 Technical description of the pipelines

### 5.1 From jetty 27

There are four separate pipelines going from the jetty manifold and connecting to the different Terminals and caverns. Under normal circumstances, a max. pumping rate of 1800 m<sup>3</sup>/h and a max. pressure of 8 Bar is permitted at the jetty manifold. The pipelines must be drained after each operation with the help of pumps located in the draining stations.

### 5.2 From jetty 1

Different pipelines of various diameters can be used for discharging depending on the product being discharged. The typical distance for pumping heavy fuel oil is approx. 1 km, and the diameter of that pipeline is between 300 – 350 mm. The pipelines must be blown empty after completion of the discharging using compressed air.

## 6 Emergency procedures

### 6.1 Responsibility

The on-board Loading Master and Ship's Master must ensure that information about the procedures to be taken in case of accidents or incidents with hazardous goods is always immediately available within their respective areas of responsibility. This information must also include the "Emergency Procedures for Ships Carrying Dangerous Goods (EmS)" and "Medical First Aid Guide (MFAG)" and/or other similar information.

### 6.2 Alarm facilities

All relevant personnel, both on-board and on land, must familiarise themselves with where the nearest alarm facilities are situated and how they should be used, before load handling commences. This includes the alarm to Gästrike Fire department. See Appendix 2 for the complete list of alarms.

The emergency stop function, both on-board and on land, must be familiar to both on-board and on land personnel.

## 7 General rules for tanker vessels at jetty

### 7.1 Warning signals

During daylight tank ships should raise the warning flag B, and during darkness they should show a red warning light situated in the signalling mast.



## **7.2 Spark extinguishers**

Vessels and craft that call at the Energy port must be equipped with effective spark extinguishers in the chimney and exhaust pipes.

## **7.3 Fire safety**

The vessel's fire safety and emergency spill equipment must be kept in full working order.

## **7.4 Watchmen on deck**

There must always be a competent watchmen on the deck of all vessels in the Energy Port. If the watchmen is not part of the vessel crew, he/she must first be approved by Port of Gävle.

The watchmen must:

- Be very familiar with **Sections 7 and 8** of the operation instructions and have good knowledge of existing safety equipment on the jetty.
- Be available on deck so that the gangway and moorings can be adjusted.
- Check that there is no oil spillage from the vessel.
- Check visitors in accordance with the ISPS code.
- Monitor that the smoking ban is complied with.
- Assist the vessel's crew in monitoring that both the vessel's and the port's safety regulations are complied with, and pay close attention to operations in the vicinity of the ship.
- Cooperate with the shore personnel so that nothing compromises safe load management.
- Notify the vessel's crew and/or Loading master of any incidents that may incur danger.
- Remove any persons who are under the influence of alcohol. If the person is an employee of the vessel, they should be kept on-board under surveillance of crew security.

## **7.5 Smoking**

Smoking is strictly forbidden on all open decks on the vessel. Smoking is only permitted in spaces designated by the Ship's master. Notices informing that smoking is not permitted must be placed in highly visible spaces.

## **7.6 Open fire – hot work on-board**

Open fires or hot work, such as welding, are not permitted on-board. Flames in the designated smoking area are exempt from this rule.

## **7.7 Repair work**

Repair work on-board (testing of radio transmitters and other electronic transmission equipment is considered repair work) should not be carried out without permission from Port of Gävle. Minor reparations requiring only hand-held tools can be exempt from this rule provided that:

- No open flames are generated.
- The ability of the vessel to move by itself is not compromised.

## **7.8 Application**

Paragraphs **8.2 to 8.5** are also applicable to vessels not carrying hazardous cargo, but which are located less than 25 metres from vessels with hazardous cargo on-board.

## **7.9 Sparks**

If sparks are observed coming from the vessel's chimney, immediate action must be taken to stop this occurring.

## **7.10 Tank hatches and sounding hatches**

All openings on-board must be closed unless controlled sampling or ullage measuring is in process.

## **7.11 Inert gas facility**

Recommendations in the latest edition of the ISGOTT must be followed regarding usage of the inert gas facility in the Energy port.



- Inert gas is defined as gas or gaseous mixtures that cannot sustain combustion or that contain less than 5% oxygen.
- An inert gas protected space is defined as a space where the level of oxygen after inerting does not exceed 8 per cent volume.

### **7.12 Loading, discharging, bunkering and de-ballasting**

Regulations regarding loading/discharging/bunkering/de-ballasting are detailed in **Section 10**.

A permit is required from Port of Gävle for loading or discharging of cargo/supplies/reserve parts in the Energy port.

### **7.13 Measures to prevent pollution of land and water areas**

It is strictly prohibited to release harmful substances or otherwise pollute Swedish land and water territory with rubbish, etc. There are places in the Energy port where a limited amount of ship-generated ballast water/sludge and other harmful substances and waste can be received.

### **7.14 Safety facilities on land**

The Ship's master and other on-board crew members are obliged to acquaint themselves with the safety facilities on land. Knowledge must include:

- Location of fire extinguishing equipment, ship/shore connections and sanitation equipment for oil spillage.
- Location of telephones and alarm boxes to alert the Fire department.

### **7.15 Photography and filming**

Photographing and filming is prohibited within Port of Gävle (including Gävle Energy port). For questions concerning permission to take photos or to film contact Port of Gävle's Port traffic office – for contact details see Appendix 6.

### **7.16 Inspection**

Port of Gävle and the Fire department have the right to inspect vessels in relation to applicable regulations. The Ship's master is obliged to implement corrections based on the inspector's findings and must assist in facilitating the inspector's work.

## **8 General rules in the Energy port**

### **8.1 Smoking and open fires**

Smoking is forbidden in the restricted areas, both indoors and outside and in vehicles. The Terminal manager may permit smoking in areas specifically approved by the Fire department.

### **8.2 Hot work, safety distance**

Hot work may only take place during discharging and loading of tankers if the following criteria are fulfilled:

- A valid permit for hot work has been granted by the Fire department and/or Terminal manager
- Those performing the hot work hold a valid certificate for such work.
- The safety distance between the hot work and the pipeline is at least:
  - 25 m for discharging/loading of Class 1 products.
  - 15 m for discharging/loading of Class 2 products.
  - 10 m for discharging/loading of Class 3 and other products.

Exceptions from these distances require additional risk assessments and analyzes as well as extra measures taken.

### **8.3 Vehicular traffic**

All vehicular traffic and usage of ignition motors is forbidden on the jetty during discharging/loading of Class 1 and 2 products.

Tractors and other work vehicles must not be used under the pipeline when class 1 products are being discharged or loaded. Vehicle passage is permitted only on the local road network.



#### **8.4 Electric equipment**

Electric equipment must be used in accordance with safety regulations issued by the electricity safety authority. Electric equipment may only be plugged in at approved plug socket points.

#### **8.5 Repair work, safety distance**

Minor repair work performed with non spark-producing tools is permitted during vessel discharging/loading. The minimum safety distances to the pipelines, provided in **paragraph 8.2**, may in some cases be reduced by Port of Gävle, after consultation with the Loading master.

#### **8.6 Fire safety**

The manager of the terminal must ensure that the fire extinguishing equipment of the facility is maintained in good working order.

#### **8.7 Spillage and leakage**

- In places where spillage and leakages may occur (at valves, taps, etc) and where there is no permanent facility for catching spilled liquids, a spill container must be used.
- All collection containers used for handling Class 1 and Class 2 products must be grounded.
- Valves, taps, air holes and such equipment for tapping, testing, water draining or similar must be kept locked or sealed if there is a risk for unauthorised tampering.

#### **8.8 Entry to the Energy Port**

Only authorised persons with a valid pass are permitted within the area. Temporary visitors/changes in crew must be notified to the Port of Gävle. The on-duty security guard on the jetty monitors this in consultation with the Loading master.

#### **8.9 Life jacket**

Life jackets must be worn at all times on jettys 1 and 27.

## **9 Loading/discharging of petroleum products and liquid chemicals**

#### **9.1 Cargo handling**

Loading and discharging of tankers must always take place in accordance with ISGOTT issued recommendations and the applicable Energy port rules. **See Chapter 1.**

#### **9.2 Loading hoses**

Only approved hoses tested during the last year are permitted to be used.

#### **9.3 Heavy fuel oil pipeline, jetty 1**

At temperatures of less than +5°C, "free flow" in the pipes must be verified by blowing air through the pipes before commencement of loading/discharging. During pumping, the temperature of the product must not exceed 70°C, and the temperature must always be maintained at more than 20°C above the pour point. The minimum discharging/loading rate is 200m<sup>3</sup>/h.

Maximum stoppage time is 30 minutes, thereafter the product must be cleared out of the pipe by compressed air to avoid the risk of blockages in the pipeline (temperature dependant).

#### **9.4 Jetty personnel**

The Loading master in charge as well and the security and pipeline guards must be present at all times during discharging/loading of tankers and draining of the pipe.

The security guard must always be present at the jetty when a vessel carrying class 1 products is moored, irrespective of whether the vessel is loading or not.



## **9.5 Emergency measures in case of fire, oil spillage or accident.**

See Appendix 3.

## **9.6 Transfer pumping between depots**

Any transfer of products between terminals within the Energy port must be notified to Port of Gävle. Notification should be made in good time, however at least 24 hours before the operation is due to start. Follow the link <https://map.gavlehamn.se/api/map/iframe>, "report work in the port area", to report pumping in the port area. The receiving terminal is the responsible terminal. Discharging and loading always take priority over transfer pumping between the terminal.

# **10 Bunkering**

## **10.1 Regulations**

Receiving of bunkers must always take place in accordance with MARPOL's rules and ISGOTT's recommendations. An ISGOTT compliant checklist must be completed and followed.

## **10.2 Bunkering manager**

The Ship's master of the receiving vessel must notify Port of Gävle of the name of the crew command responsible for the bunkering, prior to commencement.

## **10.3 Method of delivery**

Bunkers are usually only delivered by tanker lorry.

- On jetty 27 the vehicle can be parked on the jetty near the side of the vessel.
- On jetty 1 the maximum axle load is 3 tonnes and here it is necessary to use a hose from land side to the vessel.

## **10.4 Pre-notification, restrictions**

In addition to Port of Gävle, the Loading master and the security guard must also be notified of when the bunkering is planned to start. Bunkering may not occur at the same time as loading/discharging of Class 1 and Class 2 products.

# **11 Tanker cleaning**

## **11.1 General**

Cleaning of tankers is not usually permitted in the jettys. In certain instances, Port of Gävle may occasionally allow such activity.

# **12 Summary**

## **12.1 Class 1 products (Petrol)**

A security guard must always be present, even if no loading operations are in process.

Sludge collection is only permitted before or after loading/discharging.

Bunkering is only permitted before or after loading/discharging

Vehicular traffic is prohibited on the jettys during loading/discharging.

## **12.2 Class 2 products (Jet A1, Kerosene)**

A security guard must be present during loading/discharging.

Sludge collection is only permitted before or after loading/discharging.

Bunkering is only permitted before or after loading/discharging

Vehicular traffic is prohibited on the jettys during loading/discharging.



**12.3 Class 3 and Other products (EO 1-5, Diesel, Biofuels)**

A security guard must be present for loading/discharging.

Sludge collection is permitted during loading/discharging.

Bunkering is permitted during loading/discharging

Vehicular traffic is permitted on the jettys.

**NOTE: All activities on the jettys must take place in consultation with the Loading master.**

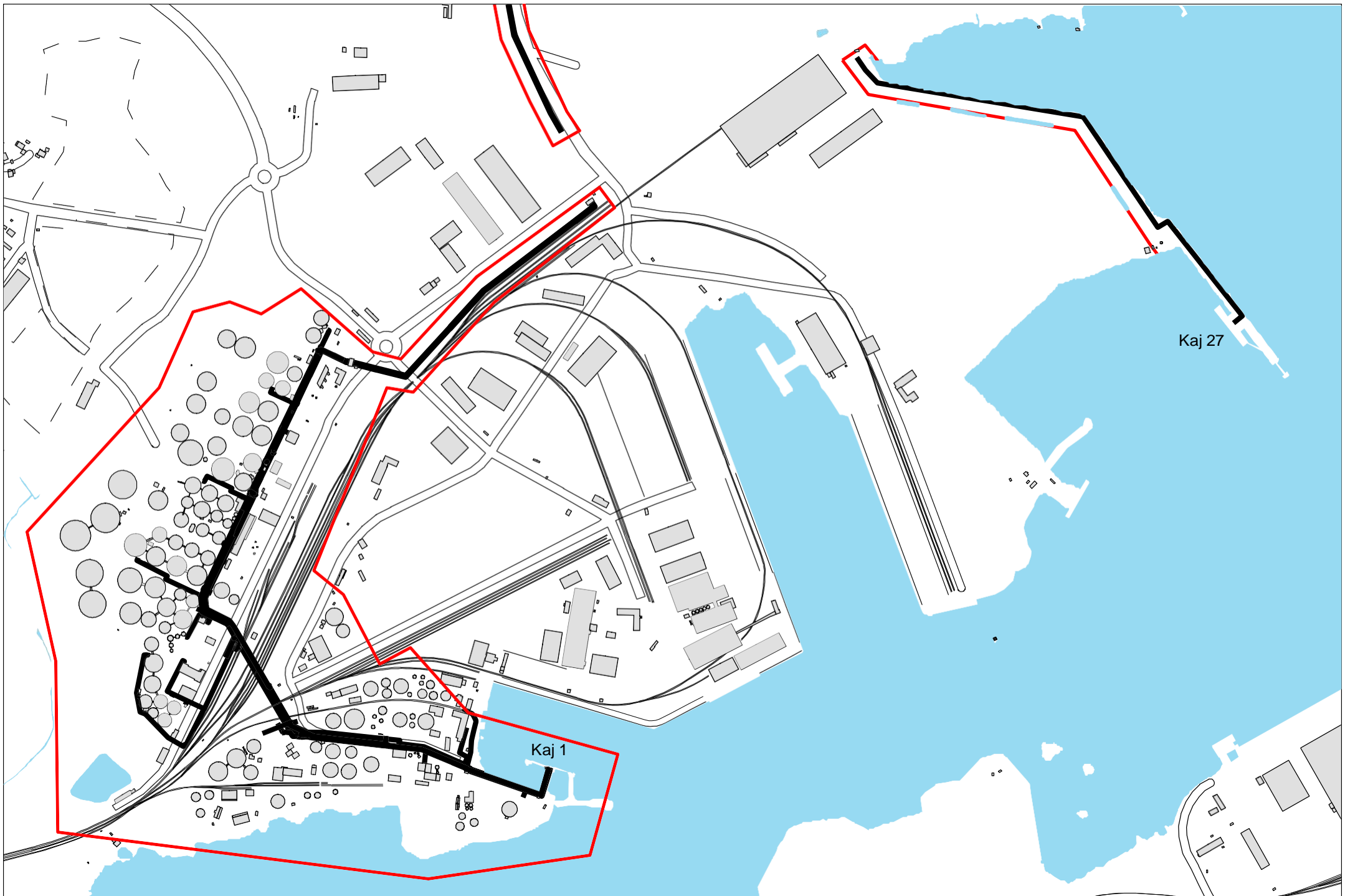

Bilaga 1





## **List of emergency contacts**

<b>Contacts in case of emergency</b>	
Fire department (SOS)	112
Port traffic office (for info. and activation of evacuation alarm)	026-17 88 66
Terminal manager for responsible terminal	
Energy port emergency response services	070-414 05 99
Energy port operation manager	070-414 05 95
Standby officer in charge (TIB)	026-17 88 66
Spill response services	010-155 61 00

<b>Other contacts</b>	
Swedish Maritime Administration (Regional office)	010-478 56 10
Swedish Maritime Administration (Pilot services Gävle)	0771-630 610
Coast guard	0776-70 70 00
Environment, health and safety authorities	026-17 80 00



## Emergency procedures in case of product spills and fire

### Spillage of class 1 products

#### Security guard:

- Activate the fire extinguishing equipment/fire alarm  
**(RED BUTTON)**
- Alert the vessel/Loading manager and 112.
- Halt any loading / discharging.
- Extinguish the fire if possible, if not then try to prevent the fire spreading.
- Contain the fire by closing all product valves on the jetty.
- Prepare to release lifting arms.
- Prepare the vessel for departure.

#### Loading master:

- Alert contacts on emergency contact list.

#### Pipeline guard:

- Contain the fire by closing all product valves in the depot and on the pipe.
- Assist the security guard.
- Guide Fire department from the entrance to the incident.

### Spillage of class 2b & 3

#### Security guard:

- Close down the drainage system from the jetty  
**(YELLOW BUTTON)**
- Alert the ship/Loading master
- Halt any loading/discharging
- Contain the fire by closing all product valves on the jetty.

#### Loading master:

- Alert contacts on emergency contact list.

#### Pipeline guard:

- Assist the security guard.
- Guide the emergency services from the entrance to the incident.

**JETTY 1**

MAX DRAUGHT (MW):	8,6 m	MAX/MIN MANIFOLD HEIGHT	N/A
MAX LOA:	190 m	ABOVE WATERLINE (MW):	3,2 m
MAX BREADTH:	28 m	QUAY DECK HEIGHT (MW):	95 m
UKC:	0,5 m	MAX BCM:	35,000 t
MIN PARALLELL BODY:	20 m	MAX DISPLACEMENT:	N/A
MIN FREEBOARD (MW):	N/A	MAX SPEED:	N/A

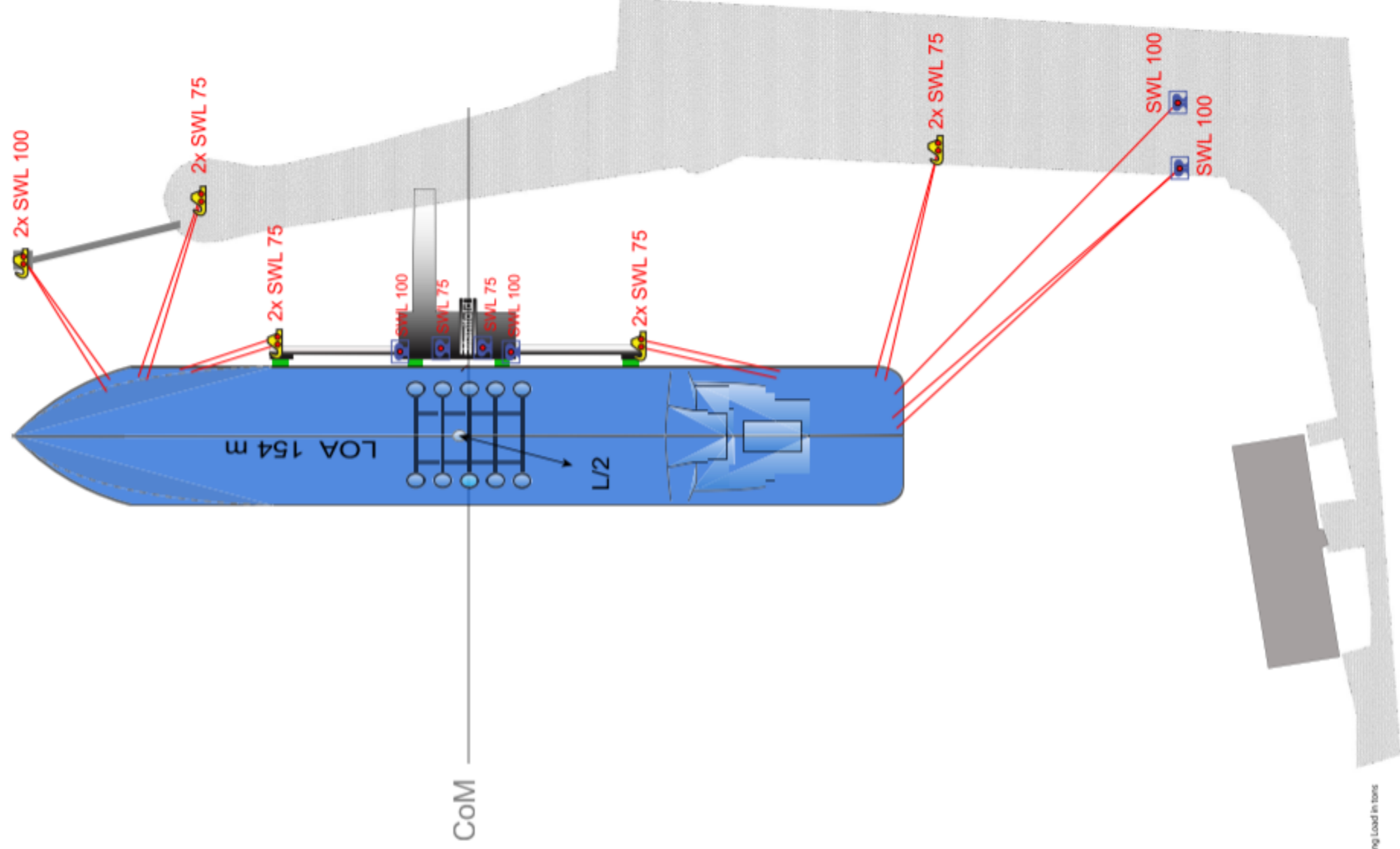

**MOORING PLAN JETTY 1**

	BERTH DIRECTION	106° / 288°
	REV. DATE	2020-04-08

DRAWN	MAFLOBE	SCALE	
REV. DATE	2020-04-08	DRAWING NO	Jetty1
APPROVED BY			

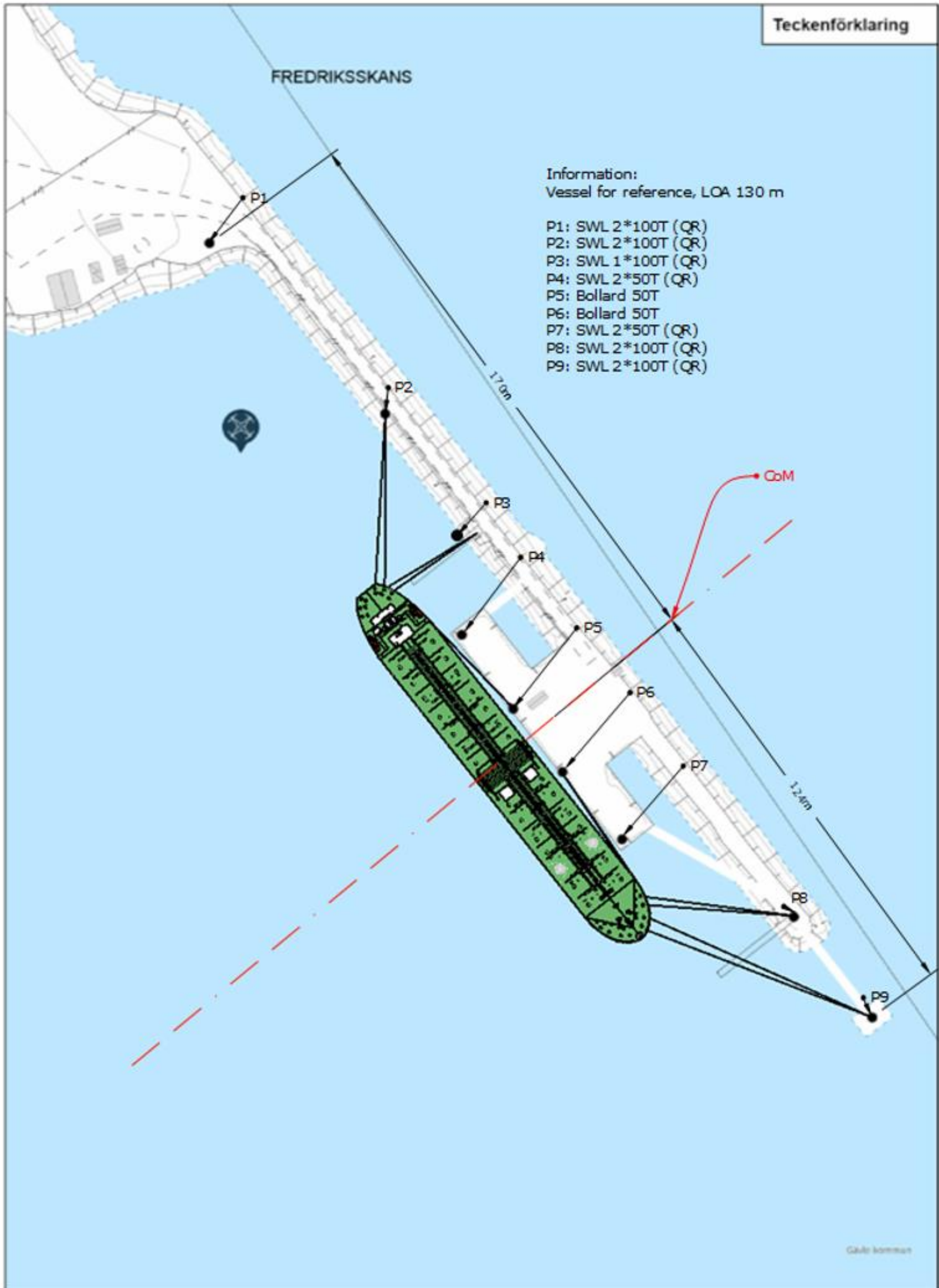

**Mooringplan Jetty 27**

Utskriven av:  
Ingemar Johansson

Datum:  
2023-07-24

Skala  
1:1 000 i A3



806 47 Gävle  
Tel: 026-17 88 43

Teckenförklaring

FREDRIKSSKANS

Information:  
Vessel for reference, LOA 180 m

- P1: SWL 2\*100T (QR)
- P2: SWL 2\*100T (QR)
- P3: SWL 1\*100T (QR)
- P4: SWL 2\*50T (QR)
- P5: Bollard 50T
- P6: Bollard 50T
- P7: SWL 2\*50T (QR)
- P8: SWL 2\*100T (QR)
- P9: SWL 2\*100T (QR)

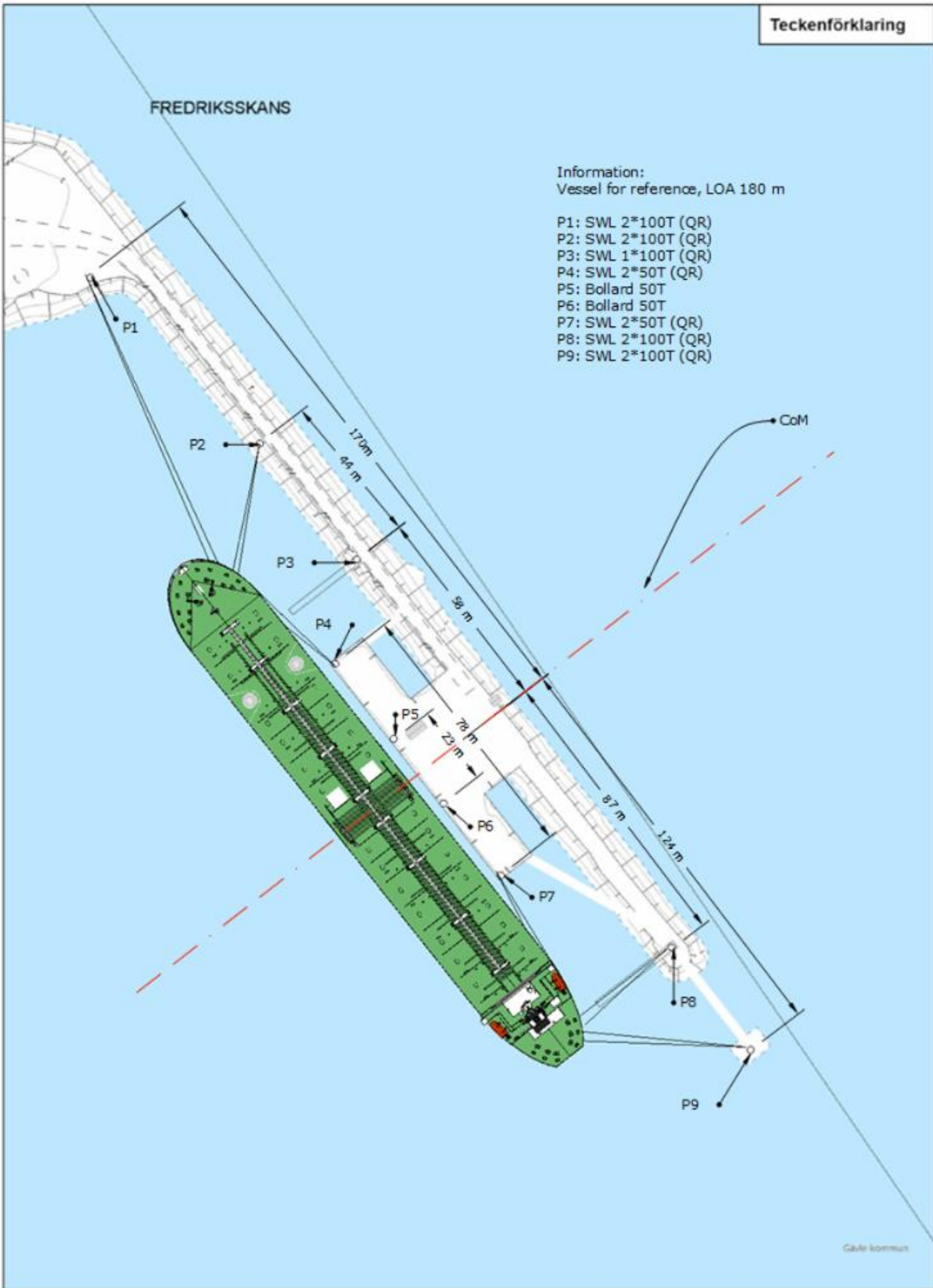

Gävle kommun

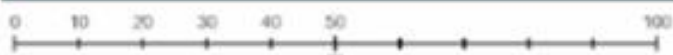

Mooringplan jetty 27

Utskriven av:  
Ingemar Johansson

Datum:  
2023-07-26

Skala  
1:1 000 i A3



806 47 Gävle  
Tel: 026-17 88 43

FREDRIKSSKANS

Information:  
Vessel for reference, LOA 245 m

- P1: SWL 2\*100T (QR)
- P2: SWL 2\*100T (QR)
- P3: SWL 1\*100T (QR)
- P4: SWL 2\*50T (QR)
- P5: Bollard 50T
- P6: Bollard 50T
- P7: SWL 2\*50T (QR)
- P8: SWL 2\*100T (QR)
- P9: SWL 2\*100T (QR)

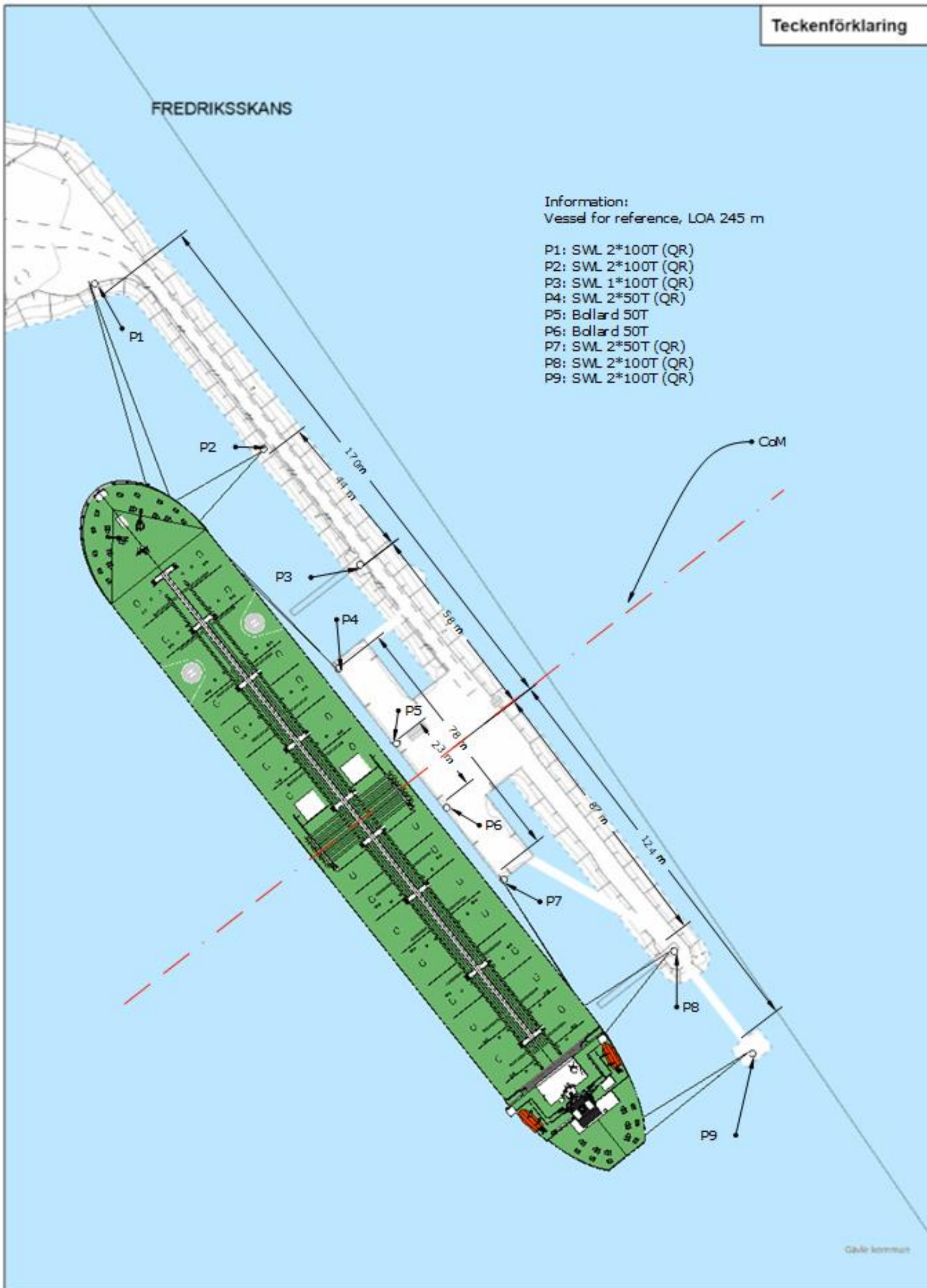

Gävle kommun

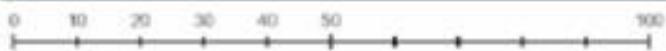

Mooringplan jetty 27



Utskriven av:  
Ingemar Johansson

Datum:  
2023-07-26

Skala  
1:1 000 i A3

806 47 Gävle  
Tel: 026-17 88 43

## JETTY QUESTIONNAIRE

Port Name: Port of Gävle (Gävle Hamn AB)  
 Date complete: 2015-10-15  
 Dates of revision: 2016-11-10, 2019-04-25, 2024-01-23

**Units used in following table:**  
 Meters (m)  
 Metric Tonnes (MT)

General Information	Jetty 1	Jetty 27	Remarks
Jetty Operator	Gävle Hamn AB (Port of Gävle)	Gävle Hamn AB (Port of Gävle)	
Jetty Position WGS 84 g/m	60°41,3198'N/17°12,7914'E	60°41,7254'N/17°14,0135'E	
Jetty Type	T jetty	T jetty/Pier	
Type of Bottom	Moraine	Moraine	
Dock Water Density	Brackish (1,003)	Brackish (1,003)	
Tidal	No	No	
IMO Port facility number:	SEGVX-0010	SEGVX-0009	
Water Depth Approaches	Northern Fairway (Holmuddsrännan)		Remarks
Water Depth in Approaches	13,4 m (RH2000)		Survey date 2021
<u>Minimum</u> Under Keel Clearance in Approaches	1,2 m		
<u>Maximum</u> Draught in Approaches	12,2 m		
Transit on Tide (High Water, Low Water, NA)	No		



<b>Water Depth Alongside</b>	<b>Jetty 1</b>	<b>Jetty 27</b>	<b>Remarks</b>
Water Depth Alongside Jetty	9,1 (RH2000)	13,4 (RH2000)	
<u>Minimum</u> Under Keel Clearance Alongside Jetty	0,5 m	0,5 m	
Absolute <u>Maximum</u> Draught Alongside *	8,6 m	12,9 m	
Are Tides Used To Calculate Draught	No, no positive draught due to tide.	No, no positive draught due to tide.	
Date of Last Hydrographic Survey	2022 autumn	2022 autumn	
<b>Dimensions</b>	<b>Jetty 1</b>	<b>Jetty 27</b>	<b>Remarks</b>
Maximum Summer Deadweight	30 000 MT	100 000 MT	
Minimum Summer Deadweight	2 000 MT	2 800 MT	
Maximum Displacement	35 000 MT	110 000 MT	
Minimum Displacement	2 800 MT	3 800 MT	
Maximum Length Over All (LOA) *	190 m	245 m	
Minimum Length Over All (LOA)	50 m	70 m	
Max Beam *	28 m	42 m	
Minimum Total Parallel Body Length	20 m	30 m	
Minimum PBL Forward of Manifold	10 m	15 m	
Minimum PBL Aft of Manifold	10 m	15 m	
Maximum Bow to Manifold Distance	85 m	124 m	Starboard at jetty (jetty no 27)



Dimensions	Jetty 1	Jetty 27	Remarks
Minimum Bow to Manifold Distance	25 m	30 m	
Maximum Stern to Manifold Distance	85 m	125 m	Starboard at jetty (jetty no 27)
Minimum Stern to Manifold Distance	25 m	30 m	
Maximum Manifold Height Above Water	13,0 m at MWL	16,8 m (10'') at MWL 19,0 m (12'') at MWL	
Minimum Manifold Height Above Water	1,0 m at MWL	1,1 m (10'') at MWL 1,1 m (12'') at MWL	
Maximum Air Draft	N/A	N/A	
Minimum Derrick / Crane SWL	1 x 1 MT	N/A	Min 5 m outreach from manifold landside
Height of jetty above MWL, approx	+3,0m	+2,9m	

\*Verify with the Port of Gävle webpage that there is no temporary restrictions under "Port Notice". [Service and terminals - Gävle Hamn \(gavlehamn.se\)](http://gavlehamn.se)

Extra Information and Facilities	Jetty 1	Jetty 27	Remarks
Minimum Mooring Arrangement	According to mooring plan	According to mooring plan	
Manifold Normally Used	Starboard	<180 m port >180 m starboard	
Vapour Recovery System Fitted	No	No	
Number & Size of Cargo Arms / Hoses	Three MLA 10" +hose connection 6-8"	Four MLA (two 10" and two 12")	
Expected Load / Discharge Rate	200-800 m <sup>3</sup> /h / 600-800 m <sup>3</sup> /h	500-1100 m <sup>3</sup> /h / 800-1800 m <sup>3</sup> /h	
Ballast / Slop Reception Facilities Available	Yes	Yes	
Are Fuel Oil Bunkers Available	Yes (by truck)	Yes (by truck)	
Are Diesel Oil Bunkers Available	Yes (by truck)	Yes (by truck)	
Is Fresh Water Available	Yes (jetty)	Yes (jetty)	

Contacts Port of Gävle			
Title	Infrastructure Manager	Operations Manager Oil/Chemistry	PFSO
Name	Daniel Karlsson	Ingemar Johansson	Port traffic office
Telephone Number	+46 70 414 06 03	+46 70 414 05 95	+46 26 178866
E-mail address	daniel.karlsson@gavlehamn.se	ingemar.johansson@gavlehamn.se	trafik@gavlehamn.se
24/7	+46 26 178866 (incl. PFSO)		
Website (Port)	<a href="http://www.gavle-port.se">www.gavle-port.se</a>		



# Flowchart

## Jetty 27

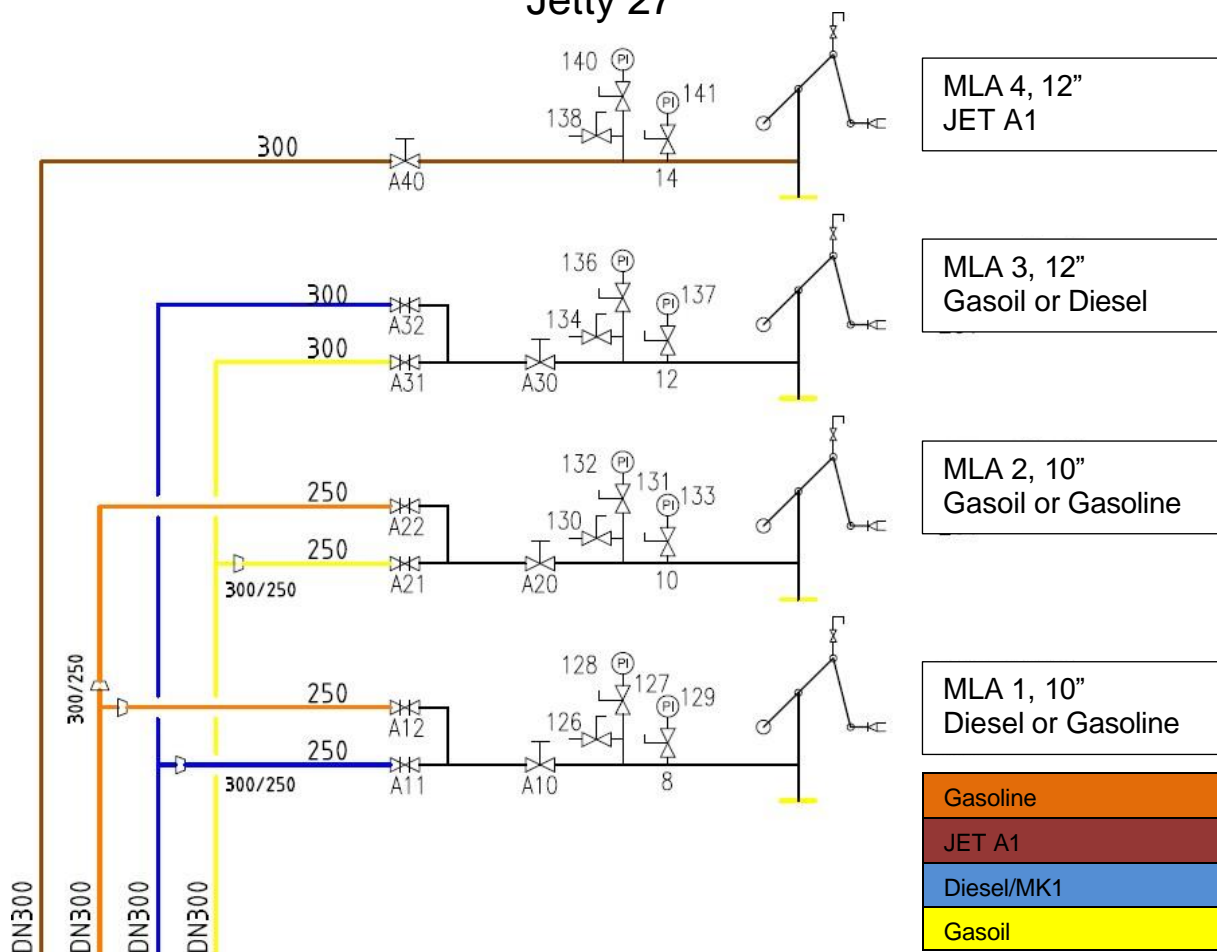

## Jetty 1

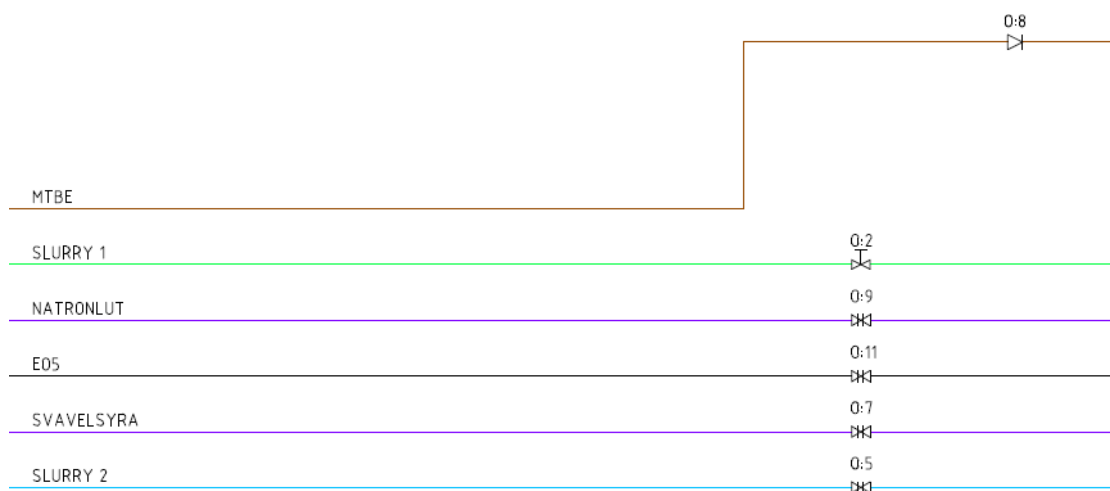

## Checks pre-arrival Ship/Shore Safety Checklist

Date and time: \_\_\_\_\_

Berth: \_\_\_\_\_

Ship's name: \_\_\_\_\_

Port / Terminal: \_\_\_\_\_

Product to be transferred: \_\_\_\_\_

Part 1A. Tanker: checks pre-arrival			
Item	Check	Status	Remarks
1	Pre-arrival information is exchanged (21.2.3)	<input type="checkbox"/> Yes	Flashpoint of previous cargo..... Tanker to terminal information (ref. 21.2.3).
1b	Request of bunker, slop or sludge operation during cargo handling.	<input type="checkbox"/> Yes <input type="checkbox"/> No	Request of SIMOPS
2	International shore fire connection is available (5.5, 19.4.3.1)	<input type="checkbox"/> Yes	
3	Transfer equipment such as manifold, reducers and hoses onboard are of suitable size and construction to fit terminal manifold or MLA. (18.2)	<input type="checkbox"/> Yes	Date of last pressure test.....
4	Terminal and port information reviewed (15.2.2)	<input type="checkbox"/> Yes	
5	Pre-berthing information is exchanged (21.3, 22.3)	<input type="checkbox"/> Yes	Pre-planning of gangway and accommodation ladder is made in collaboration with the terminal.
6	Pressure/vacuum valves and/or high velocity vents are operational (11.1.8)	<input type="checkbox"/> Yes	
7	Fixed and portable oxygen analysers are operational (2.4)	<input type="checkbox"/> Yes	

Part 1B. Tanker: checks pre-arrival if using an inert gas system			
Item	Check	Status	Remarks
8	Inert gas system pressure and oxygen recorders are operational (11.1.5.2, 11.1.11)	<input type="checkbox"/> Yes	
9	Inert gas system and associated equipment are operational (11.1.5.2, 11.1.11)	<input type="checkbox"/> Yes	
10	Cargo tank atmospheres' oxygen content is less than 8% (11.1.3)	<input type="checkbox"/> Yes	
11	Cargo tank atmospheres are at positive pressure (11.1.3)	<input type="checkbox"/> Yes	

Part 2. Terminal: checks pre-arrival			
Item	Check	Status	Remarks
12	Pre-arrival information is exchange ( 21.2.2)	<input type="checkbox"/> Yes	Information regarding request of: bunker, slop or sludge handling and bunkering during cargo handling.
12b	SIMOPS during cargo operation accepted by the terminal.	<input type="checkbox"/> Yes <input type="checkbox"/> No	According to regulations of Port of Gävle regarding bunkering, slop and sludge handling etc.
13	International shore fire connection is available (5.5, 19.4.3.1, 19.4.3.5)	<input type="checkbox"/> Yes	
14	Transfer equipment is of suitable construction (18.1, 18.2)	<input type="checkbox"/> Yes	Date of last hose pressure test.....
15	Terminal and port information transmitted to tanker (15.2.2)	<input type="checkbox"/> Yes	
16	Pre-berthing information is exchanged (21.3, 22.3)	<input type="checkbox"/> Yes	Gangway, Accomodation ladder information e.g. landing area and angle.

Date and time: \_\_\_\_\_

Berth: \_\_\_\_\_

Ship's name: \_\_\_\_\_

Port / Terminal: \_\_\_\_\_

Product to be transferred: \_\_\_\_\_

## Checks after mooring Ship/Shore Safety Checklist

Part 3. Tanker: checks after mooring			
Item	Check	Status	Remarks
17	Fendering is effective (22.4.1)	<input type="checkbox"/> Yes	
18	Mooring arrangement is effective (22.2, 22.4.3)	<input type="checkbox"/> Yes	According to mooring plan for the berth.
19	Access to and from the tanker is safe (16.4)	<input type="checkbox"/> Yes	According to port requirements.
20	Scuppers and savealls are plugged (23.7.4, 23.7.5)	<input type="checkbox"/> Yes	
21	Cargo system sea connections and overboard discharges are secured (23.7.3)	<input type="checkbox"/> Yes	
22	Very high frequency and ultra high frequency transceivers are set to low power mode (4.11.6, 4.13.2.2)	<input type="checkbox"/> Yes	AIS to be kept on when alongside and set to low power.
23	External openings in superstructures are controlled (23.1)	<input type="checkbox"/> Yes	
24	Pumproom ventilation is effective (10.12.2)	<input type="checkbox"/> Yes	
25	Medium frequency/high frequency radio antennae are isolated (4.11.4, 4.13.2.1)	<input type="checkbox"/> Yes	
26	Accommodation spaces are at positive pressure (23.2)	<input type="checkbox"/> Yes	
27	Fire control plans are readily available (9.11.2.5)	<input type="checkbox"/> Yes	Location.....
27b	The High Voltage Connection onboard is ready according to the ports requirements.	<input type="checkbox"/> Yes	

Part 4. Terminal: checks after mooring			
Item	Check	Status	Remarks
28	Fendering is effective (22.4.1)	<input type="checkbox"/> Yes	Check parallel body and/or hull to fender full contact.
29	Tanker is moored according to the port mooring plan (22.2, 22.4.3)	<input type="checkbox"/> Yes	
30	Access to and from the jetty is safe (16.4)	<input type="checkbox"/> Yes	Check gangway landing area and angle. Check accommodation ladder landing area check.
31	Spill containment and sumps are secure (18.4.2, 18.4.3, 23.7.4, 23.7.5)	<input type="checkbox"/> Yes	
31b	The OPS system is ready for connection.	<input type="checkbox"/> Yes	OPS - Onshore Power Supply

## Checks pre-transfer Ship/Shore Safety Checklist

Part 5A. Tanker and terminal: pre-transfer conference				
Item	Check	Tanker status	Terminal status	Remarks
32	Tanker is ready to move at agreed notice period (9.11, 21.7.1.1, 22.5.4)	<input type="checkbox"/> Yes	<input type="checkbox"/> Yes	
33	Effective tanker and terminal communications are established (21.1.1, 21.1.2)	<input type="checkbox"/> Yes	<input type="checkbox"/> Yes	Primary System:..... Backup system:.....
34	Transfer equipment is in safe condition (isolated, drained and de-pressurised) (18.4.1)	<input type="checkbox"/> Yes	<input type="checkbox"/> Yes	Safe to open prior connection.
35	Operation supervision and watchkeeping is adequate (7.9, 23.11)	<input type="checkbox"/> Yes	<input type="checkbox"/> Yes	On board and at terminal.
36	There are sufficient personnel to deal with an emergency (9.11.2.2, 23.11)	<input type="checkbox"/> Yes	<input type="checkbox"/> Yes	
37	Smoking restrictions and designated smoking areas are established (4.10, 23.10)	<input type="checkbox"/> Yes	<input type="checkbox"/> Yes	Nominated smoking rooms onboard: .....
38	Naked light restrictions are established (4.10.1)	<input type="checkbox"/> Yes	<input type="checkbox"/> Yes	
39	Control of electrical and electronic devices is agreed (4.11, 4.12)	<input type="checkbox"/> Yes	<input type="checkbox"/> Yes	Ban of equipments e.g. mobiles, smart watches, E-cigarettes, fitness wristbands, remote controls etc.
40	Means of emergency escape from both tanker and terminal are established (20.5)	<input type="checkbox"/> Yes	<input type="checkbox"/> Yes	
41	Firefighting equipment is ready for use (5, 19.4, 23.8)	<input type="checkbox"/> Yes	<input type="checkbox"/> Yes	
42	Oil spill clean-up material is available (20.4)	<input type="checkbox"/> Yes	<input type="checkbox"/> Yes	
43	Manifolds are properly connected (23.6.1)	<input type="checkbox"/> Yes	<input type="checkbox"/> Yes	
44	Sampling and gauging protocols are agreed (23.5.3.2, 23.7.7.5)	<input type="checkbox"/> Yes	<input type="checkbox"/> Yes	
45	Procedures for cargo, bunkers and ballast handling operations are agreed (21.4, 21.5, 21.6)	<input type="checkbox"/> Yes	<input type="checkbox"/> Yes	Cargo handling plan agreed.
46	Cargo transfer management controls are agreed (12.1)	<input type="checkbox"/> Yes	<input type="checkbox"/> Yes	Closed operation, pumping rates etc.
47	Cargo tank cleaning requirements, including crude oil washing, are agreed (12.3, 12.5, 21.4.1)	<input type="checkbox"/> Yes	<input type="checkbox"/> Yes	See also parts 7B/7C as applicable

Part 5A. Tanker and terminal: pre-transfer conference (cont.)				
Item	Check	Tanker status	Terminal status	Remarks
48	Cargo tank gas freeing arrangements agreed (12.4)	<input type="checkbox"/> Yes	<input type="checkbox"/> Yes	See also part 7C
49	Cargo and bunker slop handling requirements agreed (12.1, 21.2, 21.4)	<input type="checkbox"/> Yes	<input type="checkbox"/> Yes	See also part 7C. Information from Pre-arrival exchange.
50	Routine for regular checks on cargo transferred are agreed (23.7.2)	<input type="checkbox"/> Yes	<input type="checkbox"/> Yes	All changes must be recorded.
51	Emergency signals and shutdown procedures are agreed (12.1.6.3, 18.5, 21.1.2)	<input type="checkbox"/> Yes	<input type="checkbox"/> Yes	ESD-procedure.
52	Safety data sheets are available (1.4.4, 20.1, 21.4)	<input type="checkbox"/> Yes	<input type="checkbox"/> Yes	SDS - Safety Data Sheet or MSDS - Material Safety Data Sheet.
53	Hazardous properties of the products to be transferred are discussed (1.2, 1.4) Also consider hazardous properties from previous cargo standing in manifold to be used.	<input type="checkbox"/> Yes	<input type="checkbox"/> Yes	H2S Content ..... Mercaptan Content ..... Benzene Content .....
54	Electrical insulation of the tanker/terminal interface is effective (12.9.5, 17.4, 18.2.14)	<input type="checkbox"/> Yes	<input type="checkbox"/> Yes	
55	Tank venting system and closed operation procedures are agreed (11.3.3.1, 21.4, 21.5, 23.3.3)	<input type="checkbox"/> Yes	<input type="checkbox"/> Yes	Venting method.....
56	Vapour return line operational parameters are agreed, when applicable (11.5, 18.3, 23.7.7)	<input type="checkbox"/> Yes	<input type="checkbox"/> Yes	
57	Measures to avoid back-filling are agreed (12.1.13.7)	<input type="checkbox"/> Yes	<input type="checkbox"/> Yes	
58	Status of unused cargo and bunker connections is satisfactory (23.7.1, 23.7.6)	<input type="checkbox"/> Yes	<input type="checkbox"/> Yes	Spills and leaks prevention. Blank flanges fully bolted.
59	Portable very high frequency and ultra high frequency radios are intrinsically safe (4.12.4, 21.1.1)	<input type="checkbox"/> Yes	<input type="checkbox"/> Yes	UHF/VHF/Torches etc. to be Ex-approved.
60	Procedures for receiving nitrogen from terminal to cargo tank are agreed (12.1.14.8)	<input type="checkbox"/> Yes	<input type="checkbox"/> Yes	

## Additional for chemical tankers      Checks pre-transfer

Part 5B. Tanker and terminal: bulk liquid chemicals. Checks pre-transfer				
Item	Check	Tanker status	Terminal status	Remarks
61	Inhibition certificate received (if required) from manufacturer	<input type="checkbox"/> Yes	<input type="checkbox"/> Yes	
62	Appropriate personal protective equipment identified and available (4.8.1)	<input type="checkbox"/> Yes	<input type="checkbox"/> Yes	
63	Countermeasures against personal contact with cargo are agreed (1.4)	<input type="checkbox"/> Yes	<input type="checkbox"/> Yes	
64	Cargo handling rate and relationship with valve closure times and automatic shutdown systems is agreed (16.8, 21.4, 21.5, 21.6)	<input type="checkbox"/> Yes	<input type="checkbox"/> Yes	
65	Cargo system gauge operation and alarm set points are confirmed (12.1.6.6.1)	<input type="checkbox"/> Yes	<input type="checkbox"/> Yes	



Part 5B. Tanker and terminal: bulk liquid chemicals. Checks pre-transfer (cont.)				
Item	Check	Tanker status	Terminal status	Remarks
66	Adequate portable vapour detection instruments are in use (2.4)	<input type="checkbox"/> Yes	<input type="checkbox"/> Yes	
67	Information on firefighting media and procedures is exchanged (5, 19)	<input type="checkbox"/> Yes	<input type="checkbox"/> Yes	
68	Transfer hoses confirmed suitable for the product being handled (18.2)	<input type="checkbox"/> Yes	<input type="checkbox"/> Yes	
69	Confirm cargo handling is only by a permanent installed pipeline system	<input type="checkbox"/> Yes	<input type="checkbox"/> Yes	
70	Procedures are in place to receive nitrogen from the terminal for inerting or purging (12.1.14.8)	<input type="checkbox"/> Yes	<input type="checkbox"/> Yes	

## Additional for gas tankers      Checks pre-transfer

Part 5C. Tanker and terminal: liquefied gas. Checks pre-transfer				
Item	Check	Tanker status	Terminal status	Remarks
71	Inhibition certificate received (if required) from manufacturer	<input type="checkbox"/> Yes	<input type="checkbox"/> Yes	
72	Water spray system is operational (5.3.1, 19.4.3)	<input type="checkbox"/> Yes	<input type="checkbox"/> Yes	
73	Appropriate personal protective equipment is identified and available (4.8.1)	<input type="checkbox"/> Yes	<input type="checkbox"/> Yes	
74	Remote control valves are operational	<input type="checkbox"/> Yes	<input type="checkbox"/> Yes	
75	Cargo pumps and compressors are operational	<input type="checkbox"/> Yes	<input type="checkbox"/> Yes	
76	Maximum working pressures are agreed between tanker and terminal (21.4, 21.5, 21.6)	<input type="checkbox"/> Yes	<input type="checkbox"/> Yes	
77	Reliquefaction or boil-off control equipment is operational	<input type="checkbox"/> Yes	<input type="checkbox"/> Yes	
78	Gas detection equipment is appropriately set for the cargo (2.4)	<input type="checkbox"/> Yes	<input type="checkbox"/> Yes	
79	Cargo system gauge operation and alarm set points are confirmed (12.1.6.6.1)	<input type="checkbox"/> Yes	<input type="checkbox"/> Yes	
80	Emergency shutdown systems are tested and operational (18.5)	<input type="checkbox"/> Yes	<input type="checkbox"/> Yes	Closing rate of ESD-valves: Shore.....s      Ship.....s
81	Cargo handling rate and relationship with valve closure times and automatic shutdown systems is agreed (16.8, 21.4, 21.5, 21.6)	<input type="checkbox"/> Yes	<input type="checkbox"/> Yes	
82	Maximum/minimum temperatures/pressures of the cargo to be transferred are agreed (21.4, 21.5, 21.6)	<input type="checkbox"/> Yes	<input type="checkbox"/> Yes	
83	Cargo tank relief valve settings are confirmed (12.11, 21.2, 21.4)	<input type="checkbox"/> Yes	<input type="checkbox"/> Yes	

Part 6. Tanker and terminal: agreements pre-transfer				
Part 5 item	Agreement	Details	Tanker initials	Terminal initials
32	Tanker manoeuvring readiness	Notice period (maximum) for full readiness to manoeuvre:  Period of disablement (if permitted):		
33	Security protocols	Security level:  Local requirements:		
33	Effective tanker/terminal communications	Primary system:  Backup system:		
35	Operational supervision and watchkeeping	Tanker:  Terminal:		
37 38	Dedicated smoking areas and naked lights restrictions	Tanker:  Terminal:		
45	Maximum wind, current and sea/swell criteria or other environmental factors	Stop cargo transfer: 22 m/s  Disconnect: 25 m/s  Unberth: If the weather forecast, provided by the port, indicate average winds of 22 m/s cargo handling operation must be ceased. Disconnection must be executed at wind speed of 25 m/s.		
45 46	Limits for cargo, bunkers and ballast handling	Maximum transfer rates:  Topping-off rates:  Maximum manifold pressure:  Cargo temperature:  Other limitations:		

Part 6. Tanker and terminal: agreements pre-transfer (cont.)				
Part 5 item	Agreement	Details	Tanker initials	Terminal initials
45 46	Pressure surge control	Minimum number of cargo tanks open:  Tank switching protocols:  Minimum number of cargo tanks open:  Tank switching protocols:  Full load rate:  Topping-off rate:  Closing time of automatic valves:		
46	Cargo transfer management procedures	Action notice periods:  Transfer stop protocols:		
50	Routine for regular checks on cargo transferred are agreed	Routine transferred quantity checks:		
51	Emergency signals	Tanker:  Terminal:		
55	Tank venting system	Procedure:		
55	Closed operations	Requirements:		
56	Vapour return line	Operational parameters:  Maximum flow rate:		
60	Nitrogen supply from terminal			

Part 6. Tanker and terminal: agreements pre-transfer (cont.)				
Part 5 item ref	Agreement	Details	Tanker initials	Terminal initials
83	For gas tanker only: cargo tank relief valve settings	Tank 1: Tank 2: Tank 3: Tank 4: Tank 5: Tank 6: Tank 7: Tank 8: Tank 9: Tank 10:		
XX	Exceptions and additions	Special issues that both parties should be aware of:		

Part 7A. General tanker: checks pre-transfer			
Item	Check	Status	Remarks
84	Portable drip trays are correctly positioned and empty (23.7.5)	<input type="checkbox"/> Yes	
85	Individual cargo tank inert gas supply valves are secured for cargo plan (12.1.13.4)	<input type="checkbox"/> Yes	
86	Inert gas system delivering inert gas with oxygen content not more than 5% (11.1.3)	<input type="checkbox"/> Yes	
87	Cargo tank high level alarms are operational (12.1.6.6.1)	<input type="checkbox"/> Yes	
88	All cargo, ballast and bunker tanks openings are secured (23.3)	<input type="checkbox"/> Yes	

Part 7B. Tanker: checks pre-transfer if crude oil washing is planned			
Item	Check	Status	Remarks
89	The completed pre-arrival crude oil washing checklist, as contained in the approved crude oil washing manual, is copied to terminal (12.5.2, 21.2.3)	<input type="checkbox"/> Yes	
90	Crude oil washing checklists for use before, during and after crude oil washing are in place ready to complete, as contained in the approved crude oil washing manual (12.5.2, 21.6)	<input type="checkbox"/> Yes	

## Checks after pre-transfer conference Ship/Shore Safety Checklist

For tankers that will perform tank cleaning alongside and/or gas freeing alongside

Part 7C. Tanker: checks prior to tank cleaning and/or gas freeing			
Item	Check	Status	Remarks
91	Permission for tank cleaning operations is confirmed (21.2.3, 21.4, 25.4.3)	<input type="checkbox"/> Yes	Tank cleaning at quayside is not allowed without special permit.
92	Permission for gas freeing operations is confirmed (12.4.3)	<input type="checkbox"/> Yes	Gas freeing at quayside is not allowed without special permit.
93	Tank cleaning procedures are agreed (12.3.2, 21.4, 21.6)	<input type="checkbox"/> Yes	Permission to be granted from the Port Authority.
94	If cargo tank entry is required, procedures for entry have been agreed with the terminal (10.5)	<input type="checkbox"/> Yes	
95	Slop reception facilities and requirements are confirmed (12.1, 21.2, 21.4)	<input type="checkbox"/> Yes	

### Declaration

We the undersigned have checked the items in the applicable parts 1 to 7 as marked and signed below:

	Tanker	Terminal
Part 1A. Tanker: checks pre-arrival	<input type="checkbox"/>	<input type="checkbox"/>
Part 1B. Tanker: checks pre-arrival if using an inert gas system	<input type="checkbox"/>	<input type="checkbox"/>
Part 2. Terminal: checks pre-arrival	<input type="checkbox"/>	<input type="checkbox"/>
Part 3. Tanker: checks after mooring	<input type="checkbox"/>	<input type="checkbox"/>
Part 4. Terminal: checks after mooring	<input type="checkbox"/>	<input type="checkbox"/>
Part 5A. Tanker and terminal: pre-transfer conference	<input type="checkbox"/>	<input type="checkbox"/>
Part 5B. Tanker and terminal: bulk liquid chemicals. Checks pre-transfer	<input type="checkbox"/>	<input type="checkbox"/>
Part 5C. Tanker and terminal: liquefied gas. Checks pre-transfer	<input type="checkbox"/>	<input type="checkbox"/>
Part 6. Tanker and terminal: agreements pre-transfer	<input type="checkbox"/>	<input type="checkbox"/>
Part 7A. General tanker: checks pre-transfer	<input type="checkbox"/>	<input type="checkbox"/>
Part 7B. Tanker: checks pre-transfer if crude oil washing is planned	<input type="checkbox"/>	<input type="checkbox"/>
Part 7C. Tanker: checks prior to tank cleaning and/or gas freeing	<input type="checkbox"/>	<input type="checkbox"/>

In accordance with the guidance in chapter 25 of ISGOTT, we have satisfied ourselves that the entries we have made are correct to the best of our knowledge and that the tanker and terminal are in agreement to undertake the transfer operation.

We have also agreed to carry out the repetitive checks noted in parts 8 and 9 of the ISGOTT SSSCL, which should occur at intervals of not more than \_\_\_\_ hours for the tanker and not more than \_\_\_\_ hours for the terminal.

If, to our knowledge, the status of any item changes, we will immediately inform the other party.

Ship	Terminal
Name	Name
Rank	Position
Signature	Signature
Date	Date
Time	Time

## Checks during transfer Ship/Shore Safety Checklist

## Repetitive checks

Part 8. Tanker: repetitive checks during and after transfer								
Item ref	Check	Time	Time	Time	Time	Time	Time	Remarks
Interval time:..... hrs								
8	Inert gas system pressure and oxygen recording operational	<input type="checkbox"/> Yes	<input type="checkbox"/> Yes	<input type="checkbox"/> Yes	<input type="checkbox"/> Yes	<input type="checkbox"/> Yes	<input type="checkbox"/> Yes	
9	Inert gas system and all associated equipment are operational	<input type="checkbox"/> Yes	<input type="checkbox"/> Yes	<input type="checkbox"/> Yes	<input type="checkbox"/> Yes	<input type="checkbox"/> Yes	<input type="checkbox"/> Yes	
11	Cargo tank atmospheres are at positive pressure	<input type="checkbox"/> Yes	<input type="checkbox"/> Yes	<input type="checkbox"/> Yes	<input type="checkbox"/> Yes	<input type="checkbox"/> Yes	<input type="checkbox"/> Yes	
18	Mooring arrangement is effective	<input type="checkbox"/> Yes	<input type="checkbox"/> Yes	<input type="checkbox"/> Yes	<input type="checkbox"/> Yes	<input type="checkbox"/> Yes	<input type="checkbox"/> Yes	
19	Access to and from the tanker is safe	<input type="checkbox"/> Yes	<input type="checkbox"/> Yes	<input type="checkbox"/> Yes	<input type="checkbox"/> Yes	<input type="checkbox"/> Yes	<input type="checkbox"/> Yes	Gangway angle and landing area.
20	Scuppers and savealls are plugged	<input type="checkbox"/> Yes	<input type="checkbox"/> Yes	<input type="checkbox"/> Yes	<input type="checkbox"/> Yes	<input type="checkbox"/> Yes	<input type="checkbox"/> Yes	
23	External openings in superstructures are controlled	<input type="checkbox"/> Yes	<input type="checkbox"/> Yes	<input type="checkbox"/> Yes	<input type="checkbox"/> Yes	<input type="checkbox"/> Yes	<input type="checkbox"/> Yes	
24	Pumproom ventilation is effective	<input type="checkbox"/> Yes	<input type="checkbox"/> Yes	<input type="checkbox"/> Yes	<input type="checkbox"/> Yes	<input type="checkbox"/> Yes	<input type="checkbox"/> Yes	
28	Fendering is effective	<input type="checkbox"/> Yes	<input type="checkbox"/> Yes	<input type="checkbox"/> Yes	<input type="checkbox"/> Yes	<input type="checkbox"/> Yes	<input type="checkbox"/> Yes	Check parallel body and/or hull to fender full contact.
32	Tanker is ready to move at agreed notice period	<input type="checkbox"/> Yes	<input type="checkbox"/> Yes	<input type="checkbox"/> Yes	<input type="checkbox"/> Yes	<input type="checkbox"/> Yes	<input type="checkbox"/> Yes	
33	Communications are effective	<input type="checkbox"/> Yes	<input type="checkbox"/> Yes	<input type="checkbox"/> Yes	<input type="checkbox"/> Yes	<input type="checkbox"/> Yes	<input type="checkbox"/> Yes	Check communication.
35	Supervision and watchkeeping is adequate	<input type="checkbox"/> Yes	<input type="checkbox"/> Yes	<input type="checkbox"/> Yes	<input type="checkbox"/> Yes	<input type="checkbox"/> Yes	<input type="checkbox"/> Yes	
36	Sufficient personnel are available to deal with an emergency	<input type="checkbox"/> Yes	<input type="checkbox"/> Yes	<input type="checkbox"/> Yes	<input type="checkbox"/> Yes	<input type="checkbox"/> Yes	<input type="checkbox"/> Yes	
37	Smoking restrictions and designated smoking areas are complied with	<input type="checkbox"/> Yes	<input type="checkbox"/> Yes	<input type="checkbox"/> Yes	<input type="checkbox"/> Yes	<input type="checkbox"/> Yes	<input type="checkbox"/> Yes	
38	Naked light restrictions are complied with	<input type="checkbox"/> Yes	<input type="checkbox"/> Yes	<input type="checkbox"/> Yes	<input type="checkbox"/> Yes	<input type="checkbox"/> Yes	<input type="checkbox"/> Yes	

Part 8. Tanker: repetitive checks during and after transfer (cont.)								
39	Control of electrical devices and equipment in hazardous zones is complied with	<input type="checkbox"/> Yes	<input type="checkbox"/> Yes	<input type="checkbox"/> Yes	<input type="checkbox"/> Yes	<input type="checkbox"/> Yes	<input type="checkbox"/> Yes	Ban of equipments e.g. mobiles, smart watches, E-cigarettes, fitness wristbands, remote controls etc.
40 41 42 51	Emergency response preparedness is satisfactory	<input type="checkbox"/> Yes	<input type="checkbox"/> Yes	<input type="checkbox"/> Yes	<input type="checkbox"/> Yes	<input type="checkbox"/> Yes	<input type="checkbox"/> Yes	
54	Electrical insulation of the tanker/terminal interface is effective	<input type="checkbox"/> Yes	<input type="checkbox"/> Yes	<input type="checkbox"/> Yes	<input type="checkbox"/> Yes	<input type="checkbox"/> Yes	<input type="checkbox"/> Yes	
55	Tank venting system and closed operation procedures are as agreed	<input type="checkbox"/> Yes	<input type="checkbox"/> Yes	<input type="checkbox"/> Yes	<input type="checkbox"/> Yes	<input type="checkbox"/> Yes	<input type="checkbox"/> Yes	
85	Individual cargo tank inert gas valves settings are as agreed	<input type="checkbox"/> Yes	<input type="checkbox"/> Yes	<input type="checkbox"/> Yes	<input type="checkbox"/> Yes	<input type="checkbox"/> Yes	<input type="checkbox"/> Yes	
86	Inert gas delivery maintained at not more than 5% oxygen	<input type="checkbox"/> Yes	<input type="checkbox"/> Yes	<input type="checkbox"/> Yes	<input type="checkbox"/> Yes	<input type="checkbox"/> Yes	<input type="checkbox"/> Yes	
87	Cargo tank high level alarms are operational	<input type="checkbox"/> Yes	<input type="checkbox"/> Yes	<input type="checkbox"/> Yes	<input type="checkbox"/> Yes	<input type="checkbox"/> Yes	<input type="checkbox"/> Yes	
27b	HVSC-cable in correct position and no pull.	<input type="checkbox"/> Yes	<input type="checkbox"/> Yes	<input type="checkbox"/> Yes	<input type="checkbox"/> Yes	<input type="checkbox"/> Yes	<input type="checkbox"/> Yes	The HVSC-cable is in correct position onboard and no force tending to pull /stretch the cable.
Initials								



Part 9. Terminal: repetitive checks during and after transfer								
Item ref	Check	Time	Time	Time	Time	Time	Time	Remarks
Interval time:..... hrs								
18	Mooring arrangement is effective	<input type="checkbox"/> Yes	<input type="checkbox"/> Yes	<input type="checkbox"/> Yes	<input type="checkbox"/> Yes	<input type="checkbox"/> Yes	<input type="checkbox"/> Yes	
19	Access to and from the terminal is safe	<input type="checkbox"/> Yes	<input type="checkbox"/> Yes	<input type="checkbox"/> Yes	<input type="checkbox"/> Yes	<input type="checkbox"/> Yes	<input type="checkbox"/> Yes	Gangway angle and landing area.
28	Fendering is effective	<input type="checkbox"/> Yes	<input type="checkbox"/> Yes	<input type="checkbox"/> Yes	<input type="checkbox"/> Yes	<input type="checkbox"/> Yes	<input type="checkbox"/> Yes	Check parallel body and/or hull to fender full contact.
32	Spill containment and sumps are secure	<input type="checkbox"/> Yes	<input type="checkbox"/> Yes	<input type="checkbox"/> Yes	<input type="checkbox"/> Yes	<input type="checkbox"/> Yes	<input type="checkbox"/> Yes	
33	Communications are effective	<input type="checkbox"/> Yes	<input type="checkbox"/> Yes	<input type="checkbox"/> Yes	<input type="checkbox"/> Yes	<input type="checkbox"/> Yes	<input type="checkbox"/> Yes	Check communication.
35	Supervision and watchkeeping is adequate	<input type="checkbox"/> Yes	<input type="checkbox"/> Yes	<input type="checkbox"/> Yes	<input type="checkbox"/> Yes	<input type="checkbox"/> Yes	<input type="checkbox"/> Yes	
36	Sufficient personnel are available to deal with an emergency	<input type="checkbox"/> Yes	<input type="checkbox"/> Yes	<input type="checkbox"/> Yes	<input type="checkbox"/> Yes	<input type="checkbox"/> Yes	<input type="checkbox"/> Yes	
37	Smoking restrictions and designated smoking areas are complied with	<input type="checkbox"/> Yes	<input type="checkbox"/> Yes	<input type="checkbox"/> Yes	<input type="checkbox"/> Yes	<input type="checkbox"/> Yes	<input type="checkbox"/> Yes	
38	Naked light restrictions are complied with	<input type="checkbox"/> Yes	<input type="checkbox"/> Yes	<input type="checkbox"/> Yes	<input type="checkbox"/> Yes	<input type="checkbox"/> Yes	<input type="checkbox"/> Yes	
39	Control of electrical devices and equipment in hazardous zones is complied with	<input type="checkbox"/> Yes	<input type="checkbox"/> Yes	<input type="checkbox"/> Yes	<input type="checkbox"/> Yes	<input type="checkbox"/> Yes	<input type="checkbox"/> Yes	Ban of equipments e.g. mobiles, smart watches, E-cigarettes, fitness wristbands, remote controls etc.
40 41 47 51	Emergency response preparedness is satisfactory	<input type="checkbox"/> Yes	<input type="checkbox"/> Yes	<input type="checkbox"/> Yes	<input type="checkbox"/> Yes	<input type="checkbox"/> Yes	<input type="checkbox"/> Yes	
54	Electrical insulation of the tanker/terminal interface is effective	<input type="checkbox"/> Yes	<input type="checkbox"/> Yes	<input type="checkbox"/> Yes	<input type="checkbox"/> Yes	<input type="checkbox"/> Yes	<input type="checkbox"/> Yes	
55	Tank venting system and closed operation procedures are as agreed	<input type="checkbox"/> Yes	<input type="checkbox"/> Yes	<input type="checkbox"/> Yes	<input type="checkbox"/> Yes	<input type="checkbox"/> Yes	<input type="checkbox"/> Yes	
31b	HVSC-cable in correct position and no pull.	<input type="checkbox"/> Yes	<input type="checkbox"/> Yes	<input type="checkbox"/> Yes	<input type="checkbox"/> Yes	<input type="checkbox"/> Yes	<input type="checkbox"/> Yes	The HVSC-cable is in correct position on the jetty and no force tending to pull /stretch the cable.
Initials								